

It's a great pleasure to share This work with you .

Gr.6 Workbook answers 1st Term

TEACH_ME_PLZ



&

English 4 all

<https://t.me/english4allkuwait>

رَبَّنَا اغْفِرْ لِي وَلِوَالِدَيَّ وَلِلْمُؤْمِنِينَ يَوْمَ يَقُومُ
الْحِسَابُ
(سورة إبراهيم 41)

رَبِّ اِزْكُمَهَا كَمَا رَبَّيْتَنِي صَغِيرًا
(سورة الإسراء 24)

(سورة الإسراء 24)
رَبِّ اِزْكُمَهَا كَمَا رَبَّيْتَنِي صَغِيرًا

لا تنفسوننا من صالح دعائكم بظهور الغيب

اللهم رضاك و الجنة

OUR LORD!

FORGIVE

me & my parents
& the believers
the Day the
account is
established.

QUR'AN 14:41



Module One

Work Book

Unit One

A FAMOUS ARTIST

1. a: Complete the sentences with the words in the box.

manazz wood karouka cot
painting parents palm leaves

Look at the picture on page 2
of the Student's Book.

This is a (1) **Painting** of a bedroom in an old Kuwaiti house. The (2) **Parents** bed is on the floor. There is no (3) **Cot**.
The baby is sleeping in a basket next to the parents' bed. Soon the baby will sleep in a (4) **karouka** made of (5) **wood** or a (6) **manazz**.

1. B : What else can you see in the picture ?

Work in groups



2. True (✓) or false (x)?

✓ or x

1. Ayoub Hussein was born over seventy years ago.

/

2. He used to work in a school.

/

3. He paints pictures of modern Kuwait.

x

4. He built the Kuwait Museum.

x

5. He was thirty-four when he started working at the Kuwait Museum.

x



Correct the false sentences above and rewrite them.

3- Ayoub Hussein painted pictures of old Kuwait .

4- He worked at Kuwait Museum.

5- He was twenty four when he started working
At Kuwait Museum.

Unit 1

3. Finish the sentences with **used to** or **didn't use to**.

Huda has lived in Canada for two years. She is visiting her grandmother.

Grandmother: Would you like some milk to drink?

Huda: No, thank you. I (1) used to like milk, but I don't now.
Can I have some tea, please?

Grandmother: You (2) didn't use to like tea – you never drank it. What would you like to eat? Some yoghurt?

Huda: No, thank you. I (3) used to like yoghurt, but I prefer cheese now. Are you going to play tennis this morning?

Grandmother: No, I don't play tennis any more. I (4) used to play three times a week, but now I go swimming.

Huda: Swimming? You (5) didn't use to like swimming.

Grandmother: You're right, but now I love it. We have changed!

4. Write questions and answer them. Then ask a friend.

what / drink / when you were a baby

What did you use to drink when you were a baby?



I used to drink a lot of milk

1. who/play with/when you were five.

Who did you use to play with when you were five ?

2. what school/go to/when you were nine

What school did you use to go to when you were nine ?

3. when/go to bed/when you were six

When did you use to go to bed when you were six ?

4. which book/like best/when you were younger

Which book did you use to like best when you were younger ?

5. Write the words, then finish the sentence.

1. If the sea is _____,
it can be dangerous.

2. Tables and chairs are kinds
of _____.

3. The baby's manazz
was made of these.

4. A baby's bed.

5. We can see old Kuwait in
more than 600 of Ayoub Hussein's _____.

6. Ayoub Hussein used to be a _____

7. A very young child.

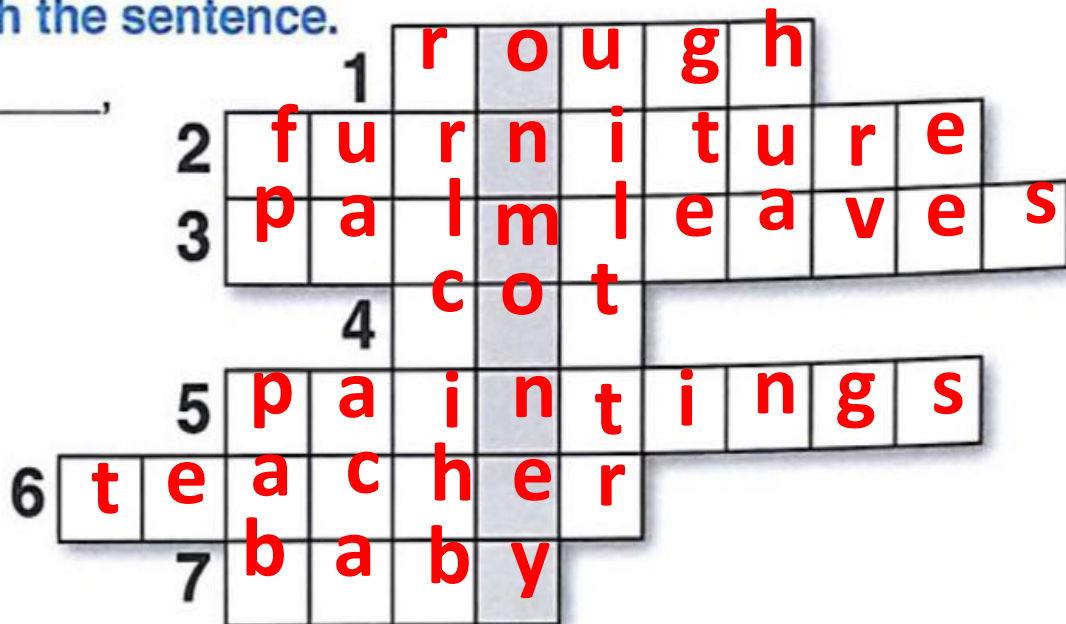



On money

I'n Kuwait, you can see some of Ayoub Hussein's paintings _____.

1 2 3 4 5 6 7

Remember!

's	
	
Example: the girl's house	Example: girls' house

6. Read. Write the underlined word with an apostrophe (') in the right place.

- The bride moved to her husbands house after one week. **husband's house**
- The girls clothes were clean. Their mothers washed them. **girls' clothes**
- The artists painting was in the museum. **artist's painting**
- The boys boats were made of wood. They sailed them every day. **boys' boats**
- The parents house was close to their son's house. **Parents' house**

7. Describe each picture in one sentence.

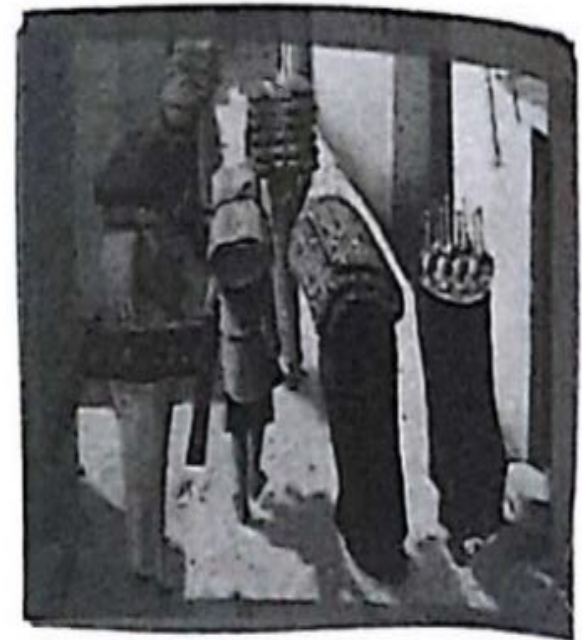

1. ... **This man is carrying a boat to the sea .**
2. ... **Two women are carrying their clothes on their heads**
3. ... **Some people are carrying pieces of furniture .**

8. Read, then draw the picture. Write.

Show a building, an animal, some people, some trees and a car, a plane or a bike.
Colour the picture, then write about it.



1. Write about your favourite painting.

My favourite painting is the sea .I like painting the sea very much . I like painting the fish and dolphins . When there is a ship landing .The view is amazing . There are some trees on the beach .Some People are swimming in the sea . The sky and the sea are clearly blue .It's the best painting I have ever painted .

2. Which is your favourite picture? Write what you can see and why you like it.

My favourite painting is the sea .I like painting the sea very much . I like painting the fish and dolphins . When there is a ship landing .The view is amazing . There are some trees on the beach .Some People are swimming in the sea . The sky and the sea are clearly blue .It's the best painting I have ever painted .

Module One

Work Book

Unit Two

AN ADVERTISEMENT FOR KUWAIT

Unit
2

Module One

An Advertisement for Kuwait

1. Answer these questions about the adverts in your Student's Book.

1. What is in the harbour in The Scientific Center?

Old dhows

2. Who feeds the sharks?

The divers do that .

3. Do you think they get in the water with the sharks?

Yes , they do .To feed them .

4. What can you see or do in Kuwait Towers?

I can see Kuwait City .I can enjoy eating in the restaurant .

5. What do you think you will see in Dickson House?

I will see old furniture and antics

6. Why do you think Failaka is famous?

Because it's got old temples and museums

2. Game. Give a friend some information. Can he/she guess the place?

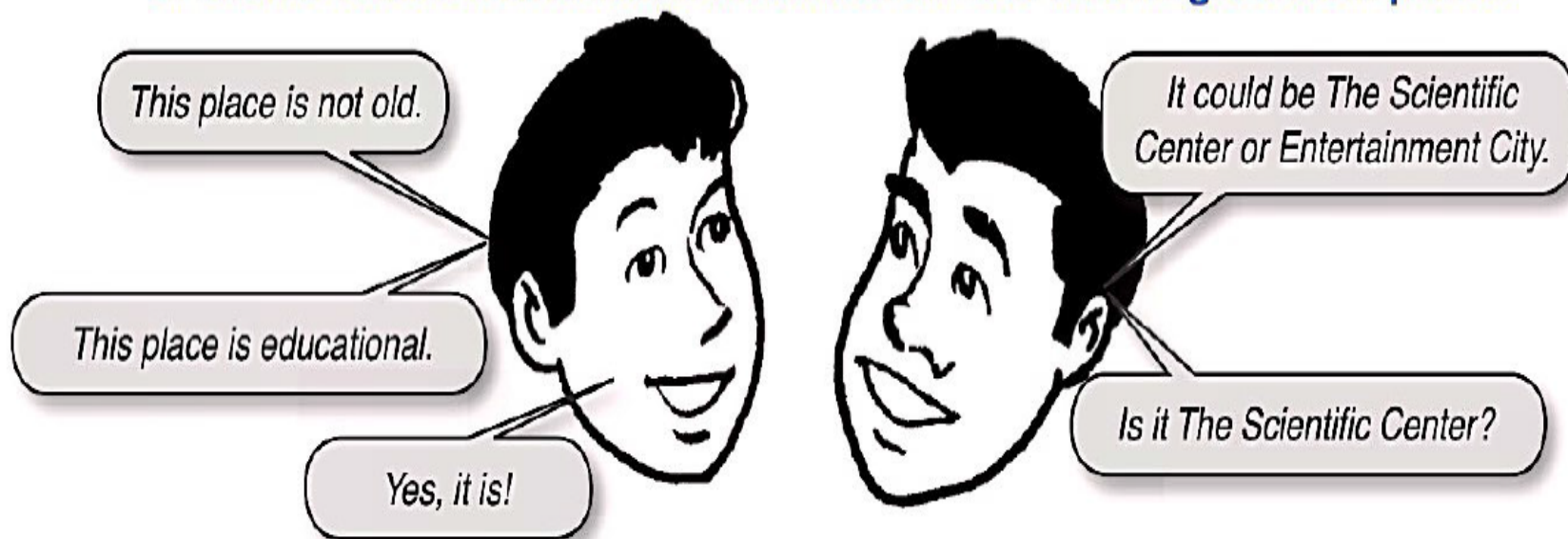

3. Write about another place you visited.

Last week, I went to somewhere .I enjoyed watching the sharks and the divers there .I saw the divers While they were feeding sharks .I also saw the old dhows . The place was amazing . I enjoyed a lot .

Remember

First conditional

Always remember:

If I do, I will

If Simple present, Future (will)

Example

If it rains, you will get wet. (affirmative)

If it doesn't rain, you won't get wet. (negative)

If you run fast , you will win the race .

If I study hard , I will pass my exams .

If Ali sleeps early , he will get up early .

If Fatima drives slowly , she won't make an accident .

4. Write the correct forms of the verbs in brackets

1. If my friend invites me, I **Will go** (go) to his house.
2. If he **doesn't come** (not come), we will start without him.
3. I will buy new shoes if I **have** (have) enough money.

3. I will buy new shoes if I (have) enough money.

5. Correct the underlined mistakes

1. I will go swimming if the weather isn't good.

is

2. If you ring the bell, someone won't open the door.

will

3. They will hear her if she speaks very quietly.

won't hear

6. Change the following sentences into negative, make sure you keep them meaningful.

1. Sara will read the e-mail today if you send it now.

Sara won't read the e-mail if you don't send it now .

2. If you train well, you will have a chance to win.

If you don't train well , you won't have a chance to win .

3. I will watch the movie if I have enough time.

I won't watch the movie if I don't have enough time .

7. Write what would say in the following situations

1. Your friend is visiting Kuwait and he likes high views.

Me too , that's amazing !

2. Your sister asks you about your plans for the summer.

We are going to travel to Dubai this summer .

3. Someone drives his car very fast.

That's very dangerous . He may hurt himself .

8. Work with your friends. A tourist is coming to Kuwait for three days. Plan his holiday.

Entertainment City

Shopping

The Grand Mosque

Failaka Island

The Red Fort

The Kuwait Towers

The National Museum

Think about:

- how long it will take to visit each place
- when and where he can eat, and
- at what time he has to start in the morning.

Remember to use the words in the box.

You should ... You could ... If you ..., you will ...

Monday: You should go to the Entertainment City .

It's amazing .

Tuesday: You could go to the Grand Mosque .

It's very spacious .

Wednesday: If you like shopping , you will go to the Avenues .

Complete the sentences with the words in the box.

and while because so or after that if first

1. In Kuwait you can swim in the sea **or** you can sit on the beach.
2. You should come to Kuwait **Because** it is a wonderful country.
3. **If** you come to Kuwait, you will have great fun!
4. Shall we have chicken **or** fish? You choose!
5. **First** we'll go shopping. **After that** we'll go to the museum.
6. **While** you're walking around Failaka, you'll see some very old buildings.
7. Kuwait is a beautiful country **so** you should visit it.

10. Think of a place to visit in Kuwait. Find a picture. Write an advert for it.

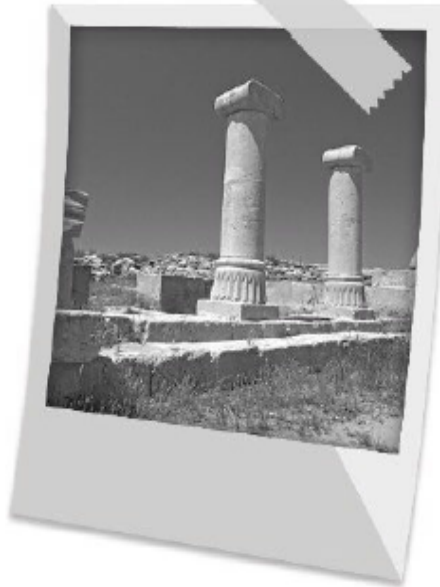

1. Choose one of the two pictures and write an advert about it.

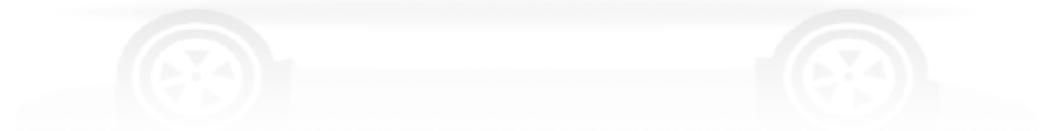

2. Write an advert for one of the pictures.

I phone Centre

KD

200

Name

We're selling I phones and accessories

What are you selling?

A great phone
Modern
Easy to use
Wi Fi



Big screen
Water proof
A variety of apps
Advanced Tech

Give information

You can buy and exchange your device

Give information

Write NOW for more information. Send this to the address at the bottom.

Name: Ahmed Abdo

Address: Mangaf , Block 1

Draw a picture

Give information

Address

Module One

Snapshots Of Kuwait

Unit Three

**A Local Television
Programme**

1. Answer R (receptionist), D (doctor) or N (nurse).

1 Who answers the phone?

R

2 Who told the nurse which medicine to give you?

D

3 Who gives you medicine?

N

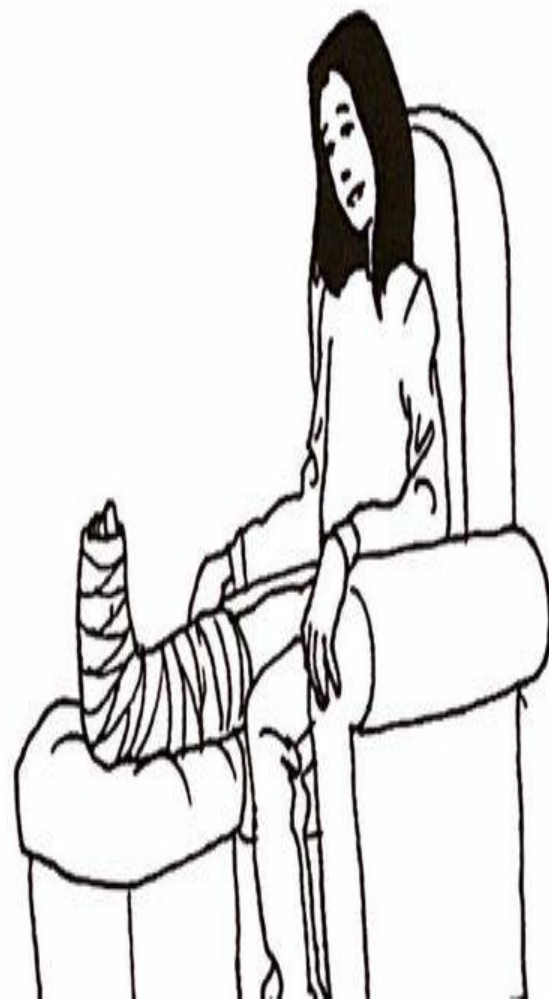

Past Simple

Regular Verb

The past tense of regular verbs: verb + **ed**

want - > wanted

play - > played

Irregular Verb

The past tense of irregular verbs

go - > went

swim - > swam

cut - > cut

put - > put

2. Complete the sentences. Use the correct form of the verbs in the box.

see meet took tell leave **hit**

1. The receptionist **told** the doctor about a man.
2. The ambulance **took** the girl to hospital.
3. Everyone **saw** the first episode on television.
4. She said that he **left** the hospital very quickly.
5. A car **hit** a girl.
6. We **met** the characters in the programme.

3. Listen to the end of the story again. Complete the paragraphs.

At (1) **the** end (2) **of** the episode,

the receptionist told (3) **them**, "A man has just

(4) **asked** about the (5) **girl**."

"Where is he?" asked (6) **the** doctor.

"He's (7) **gone**," said the receptionist. "He left (8) **very** quickly."

Remember

There are two type of questions

1- yes / no questions

Example: did you do your homework?

The answer is: yes I did or no I didn't

2- WH questions (what, where, why, how)

Example: where did you go yesterday?

The answer is: I went to school.

5. Write a full stop (.) or a question mark (?).

1. The girl didn't have a broken arm.

2. Did the ambulance drive quickly

3. Do you know who drove the car.

4. A man spoke to the receptionist.

5. Where did the girl come from.

6. The receptionist phoned the police. Match the questions and answers.

Write the answers, then ask and answer with a friend.

a) We think she is about thirteen.

c) A car hit a girl.

e) Yes, her school bag.

b) No, it's short.

d) She's 1 metre 20.

f) We don't know. She can't remember.

Policeman: What happened?

Receptionist: (1) **A car hit a girl .**

Policeman: What's her name?

Receptionist: **We don't know . She can't remember**

Policeman: How old is she?

Receptionist: **We think she's about 13 .**

Policeman: How tall is she?

Receptionist: (4) **She is 1 metre 20 .**

Policeman: Has she got long hair?

Receptionist: (5) **No , it's short .**



7. Rewrite these sentences with punctuation marks from the box.

“ ” ? , .

1. My name is Sami said the little boy

— **“ My name is Sami .” said the little boy .** _____

2. A man was driving the car said the girl

— **“ A man was driving the car .” said the girl .** _____

3. When did this happen asked the policeman

— **“ When did this happen ?” asked the policeman .** _____

4. What's your name asked the nurse I want to phone your mother

— **“ What's your name ?” asked the nurse .** _____

— **“ I want to phone your mother .”** _____

Remember

- We use (because) to explain the reason behind things.

Example: I went to the restaurant because i was hingry.

- We use (so) to explain the result of things.

Example: I was hungry so i went to the restaurant.

8. Look at the last picture in the Student's Book. Here is what the man told the police. Join the sentences.

1. I was driving along the road. I was going to work. (because)
I was driving the along the road because I was going to work.

2. My phone rang. I answered it. (so)
My phone rang so I answered it.



3. It was an important person on the phone. I listened very carefully. (so)

It was an important person so I listened very carefully.

4. I was talking to the man. I didn't see the girl. (so)

I was talking to the man so I didn't see the girl .

5. I drove home. I was frightened. (because)

I drove home because I was frightened .

6. I was worried about the girl. I went to the hospital. (so)

I was worried about the girl so I went to the hospital .

9. Discuss these questions. Work with three friends.

1. What do you prefer doing in the evenings?

I prefer watching TV with my family .

2. Which television programmes do you enjoy watching?

I enjoy watching action films .

3. What sports do you like playing?

I like playing football .

Write sentences. Use I prefer, I like, I enjoy.

Fahd and I prefer playing on the computer in the evenings, but Anwar and Ahmed prefer watching television.

Ali and I like eating pizza at Pizza Hut .

My friends and I prefer

visiting the zoo on Fridays .

I enjoy riding a horse .

I enjoy playing in the garden too .

1. Work with four friends. Think of a film. Write the information.

The name of the film:

Titanic

The name of the actors:

Silvester Stalone

Where is it?

At sea

Is it a love story?

Yes , it's a love story .

Is it funny?

Yes , it's funny .

What happens?

The actor loved a girl .
They decided to marry .

Is the music good?

Yes , it's very good .

*How many *s?*

5 stars

2. Write a report about the film. Give it to other people in your class to read.

Titanic

: a good film to watch!

I watched a film yesterday . It was Titanic.
I watched it with my family . It was fantastic .
The hero was funny and young .He loved a girl Called
Rose .They loved each other .But , they didn't marry
Because the hero drowned when he saved his girl .

3. Read the film reports in the Student's Book. Then answer and complete.

1 Which film do you want to see? **Film A**

2 Find out if other people think the same as you

Most people want to see film _____ because **It's funny .**

Film A

Read the following passage then answer the questions below:

Abdulrahman Al Sumait was born in Kuwait. He was born on October 15, 1947 and passed away in 2013. He was a physician and Islamic scholar. He studied Medicine at the University of Baghdad. Abdulrahman Al Sumait was a doctor specializing in internal medicine before working in charity work. He received more than 12 prizes and honour certificates from different organizations.



Abdulrahman Al Sumait established a human organization known as Direct Aid. In less than 30 years, Direct Aid built more than 800 schools, 4 universities, 200 medical clinics, over 200 training centres for women and 2,200 mosques. It drilled thousands of wells and constructed many agricultural projects which turned desert areas into green ones.

We learn a lot from Dr. Abdulrahman Al Sumait who spent his life serving humanity and helping the poor around the world, especially in Africa. He is known for his good deeds care and charity work.

A) Choose the correct answer from a, b, c and d:

1- The best title for the passage is

- a) Direct Aid b) A man to Remember c) Africa d) Internal Medicine

2. The underlined pronoun "which" in the second paragraph refers to

- a) Universities b) Mosques c) training d) Wells and projects

2- The underlined pronoun word deeds in the third paragraph means

- a) actions b) interests c) tasks d) benefits

4- The main idea of the third paragraph is:

- a) Abdulrahman Al Sumait as founder of Direct Aid.
b) Abdulrahman Al Sumait's biography.
c) Abdulrahman Al Sumait as great man who helped the poor.
d) Direct Aid is a humanitarian organization.

2. Do as shown between brackets:

1- My friend used to eat a lot of sweets. (Make negate)

_____ **didn't use to** _____

2- Columbus discovered AMerica in 1492. (Ask a question)

When did Columbus discover America ? _____

3- If i see a fire, I _____ **will call 112.** _____ (complete)

3. Word Search Puzzle

Find the following hidden words: aquarium - artist - broken - daughter
- husband - model

H	A	I	V	Q	A	F	L
L	Q	A	R	T	I	S	T
H	U	S	B	A	N	D	Q
D	A	U	G	H	T	E	R
Y	R	B	R	O	K	E	N
H	I	F	M	U	D	X	O
C	U	M	O	D	E	L	O
M	M	A	Q	O	P	H	N

Module Two

WorkBook

Unit Four

POTABLE WATER

1. Use the words in the box to finish the paragraph.

expensive desalination plants factories without called little build rich

There is very (1) **little** fresh water in Kuwait. People use sea water for drinking **without** the salt! It is very (3) **expensive** to take the salt out of sea water. Kuwait is a (4) **rich** country and can (5) **build** (6) **Desalination plants**. These (7) **factories** make the sea water safe to drink. Towers around the country hold the drinking water. The towers in the photo are famous, beautiful and very useful, too. One has got a restaurant, another gives light and two of them hold enough water for all of Kuwait City. They are (8) **called** the Kuwait Towers.



2. Match the definitions with the pictures and write the words:

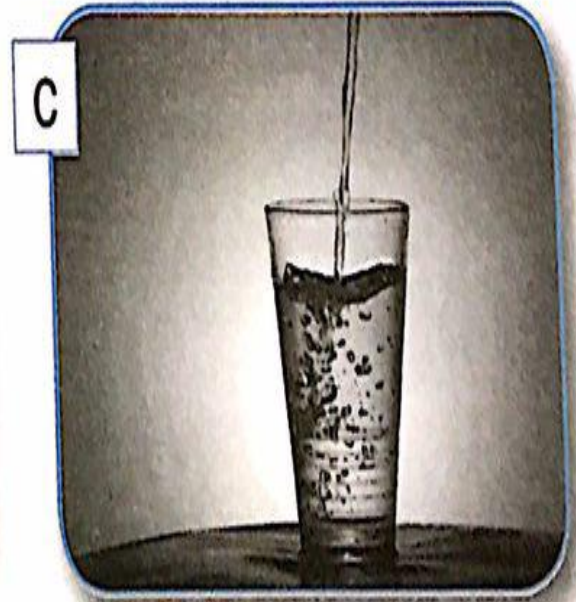
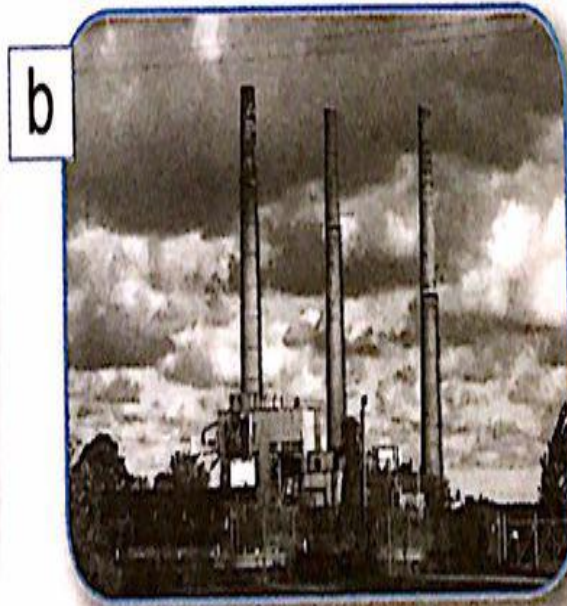

1. **factory** (**b**) a place where things are made
2. **Lake** (**a**) a large area of water with land around it.
3. **Clean water** (**c**) water which is safe to drink.

3. Match the words and pictures

1- two

2- two thirds $\frac{2}{3}$

3- one third $\frac{1}{3}$

4- one



one pizza

two thirds of a pizza

two pizza

one third of a pizza

a

b

c

d

4

2

1

3

4. Write the opposites of these words

Across →

- 1. up
- 2. difficult
- 4 hot.
- 5. good
- 6. dirty
- 8. fast
- 10. left

Down ↓

- 1. nights
- 3. big
- 4. expensive
- 7. first
- 9. cool

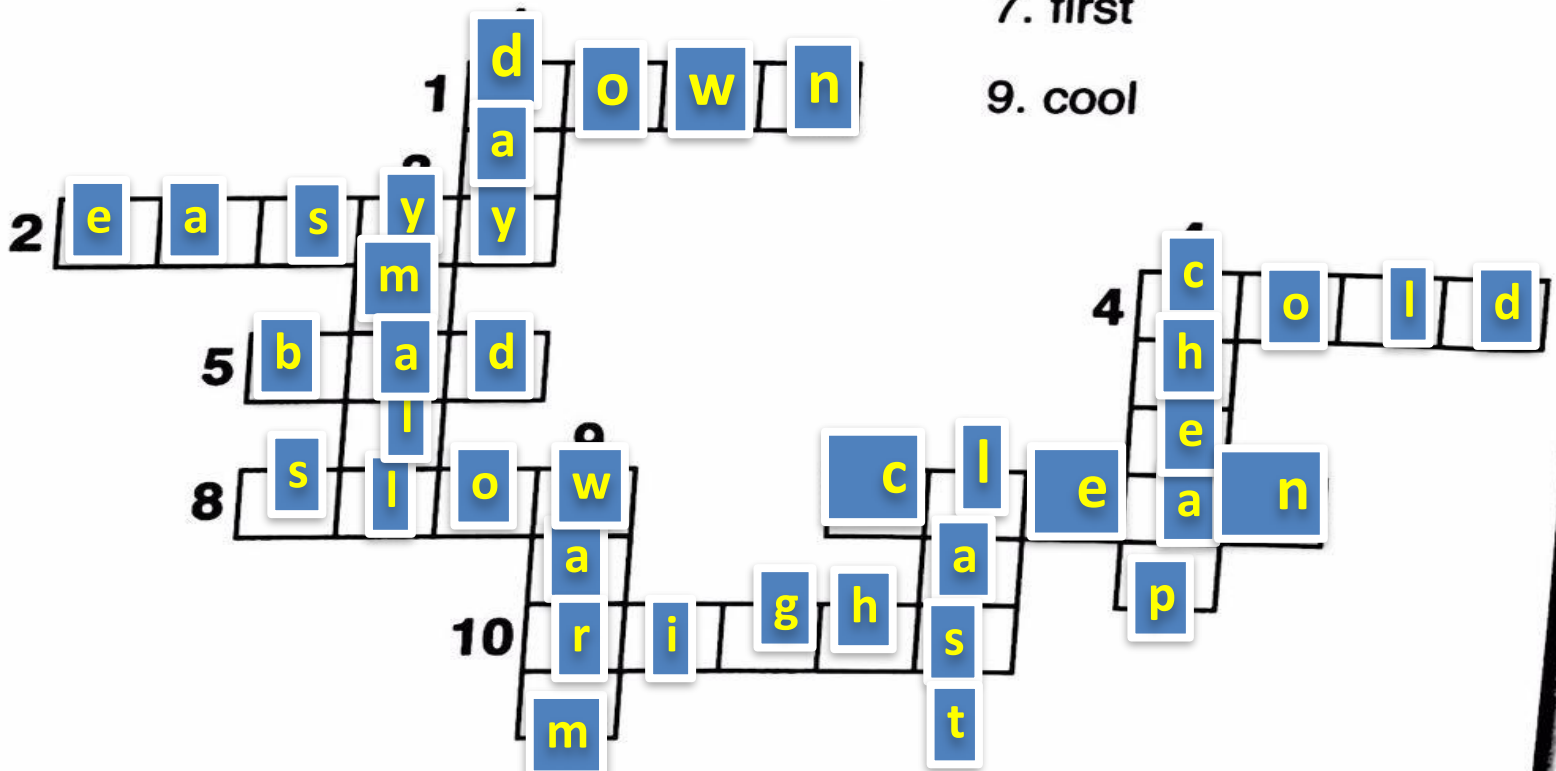

Who or which

5. Complete the sentences. Use **who** or **which** and your own ideas

Example:

They have to build desalination plants which are very expensive. I have got a friend who likes scuba diving.

Remember

We use who for people.

A journalist is someone who works for a newspaper.

We use which for things.

A hat is something which you wear on your head.

1. I have got a friend **who gets up early in the morning .**
2. Kuwait is a country **which lies on the Gulf .**
3. A giraffe is an animal **which has got a long neck .**
4. I have got a teacher **who teaches us English at school .**
5. There are some people in my class **who always go to school on foot .**

6. State whether these sentences are (✓) or false (x) and justify your answers

1 Everyone needs water to live.



2 Icebergs are easy to pull a long way.



3 If you pull an iceberg to Kuwait, it won't melt.



4 Some countries make drinking water from sea water.



5 You can find icebergs in the Antarctic.



7. Work it out with a friend

8. Try this. Tell your class what happened.

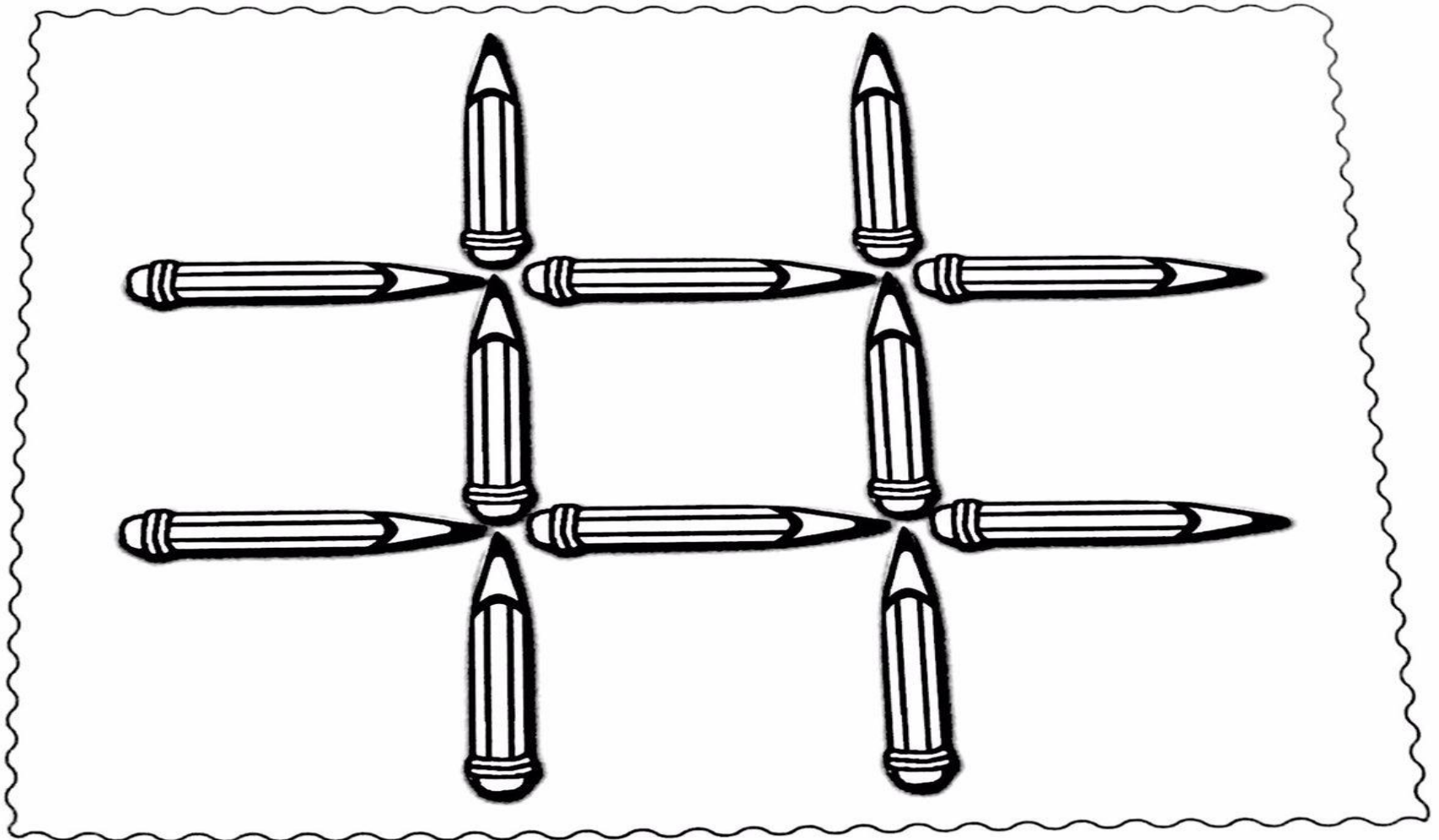

Now, move only three pencils and make three squares.

Then, tell two more friends how you did it.

1 Answer the questions.

How much water do you use when you clean your teeth?

Put a big bowl in the sink under the tap.

Put some toothpaste on your toothbrush.

How much water is there in the bowl?

How much water can you save each time?

x 2 – You brush your teeth in the morning and at night

How much can you save in a year?.

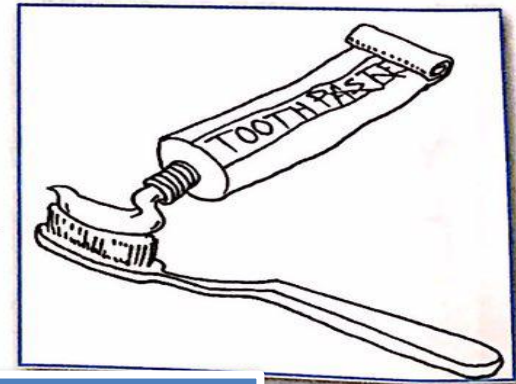
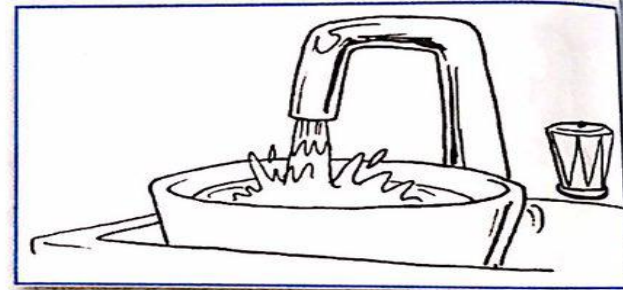

Write about what you did and what you found out.

- -There are 3 litres of water .
- I can save 2.5 litres of water each time .
- -You can save 1825 litres of water a year .

10.  Listen to these words. Which letter makes no noise?

dirty third litre quarter water

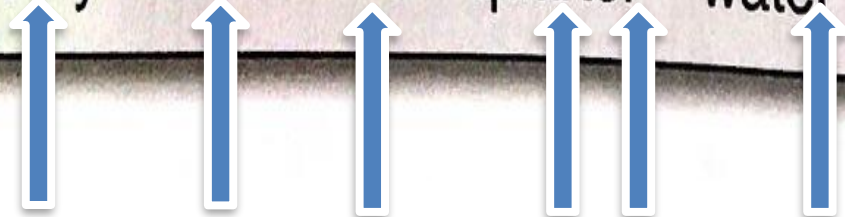

11.  Listen to these words and repeat.

1. afternoon

2. country

3. teacher

4. drink

5. wonderful

6. factory

7. brain

8. iceberg

9. dangerous

10. person

12. Think about teeth. Write four words under each line.

Good for your teeth

water

Brush

toothpaste

Tooth pick

Bad for your teeth

Fizzy drinks

Chocolate

sugar

Fast food

13. Look at your friend's words. Write more words.

Have you got the same words as your friend? Write two more words Under each title.



Think , pair and share :

14. Make a poster about teeth. Write and draw pictures.

Look after your teeth

Always brush your teeth twice a day .



Always drink water .



Don't drink fizzy drinks .



Don't eat much chocolate .



Module Two

Student Book

Unit Five

SEA WORLD SECRETS

Unit
5

Sea World Secrets

Module Two

Read about the animals on page 20 of the Student's Book again. You will find the answers there.

1- Do whale sharks eat other sharks?

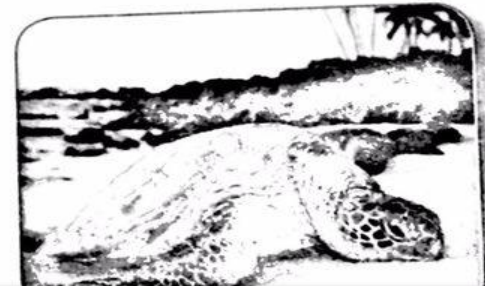
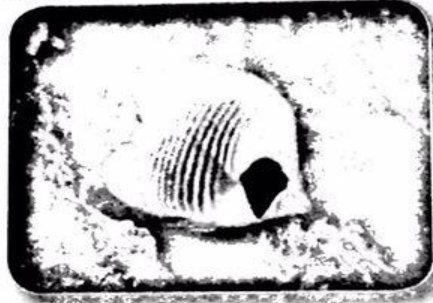
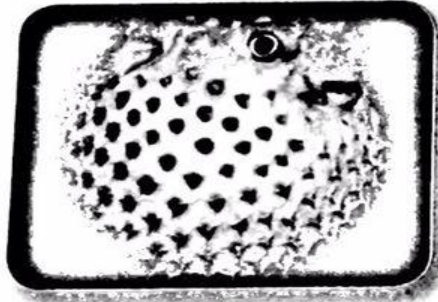

No , they don't eat them .

2- Which country can you see whale sharks near – Canada or Kuwait?

Kuwait . You can see them near it .

3- What does a puffer fish do when it is frightened?

It drinks water to look bigger .

4- Where do turtles lay their eggs?

In the sand .

5- Why do people want turtle shells?

To keep them at home as decorations .

6- Where do butterfly fish live?

In coral reefs .

2. It's Quiz time!

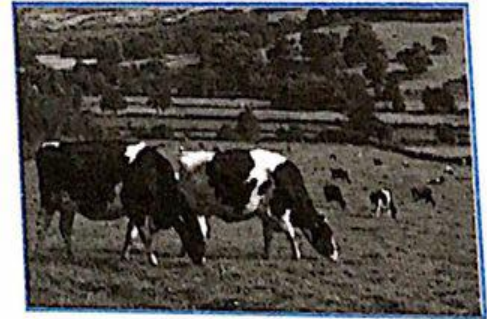

Name the animals which		
Lay eggs	Eat other animals	Live on a farm
Turtles	Lions	Cows

3. Name three wild animals

Tiger

Elephant

Monkey

4. Listen to these words. Which letter makes no noise in each.

shipwreck pattern whale

5. Underline the letters which make no noise in these words. Listen. Are you right?

1. frighten

2. when

3. lamb

4. knife

5. cupboard

6. biscuits

7. metre

8. chocolate

6 Can you see the sentences? Write them.

1 some sharks are very dangerous and can eat people

Some sharks are very dangerous and can eat people . _____

2 there is a shipwreck close to Qaruh

There is a shipwreck close to Qaruh . _____

3 some people have found treasure on shipwrecks

Some people have found treasure on shipwrecks . _____

7. Word search exercise. Find the word.

Shark

Buffer fish

Squid

Turtle

Starfish

Octopus

Whale

S N G L B L F C D **STARFISH** Q C W U

Q J M **WHALES** S W I V H D U Q L A Q

U R I Z C A T E S U **OCTOPUS** V S U O

I T O Y C P P E D M **SHARK** U O I M K P

BUFFERFISH J E B **TURTLE**

S F M N H Y T U K Q A Q E T J L M B V X S

7. Write the sentences.

Example:

I/walk on the beach/when/meet my friend

I was walking on the beach when I met my friend.

Remember

- We use the past continuous for the action that was in progress.
- We use the past simple for the completed action.

1 They/drive along the road/when/a dust storm/start

Example:

They were driving along the road when a dust storm started .

2 The ship/sail near the beach/when/hit a rock

somebody knocked at the door.

The ship was sailing near the beach when it hit a rock .

3 The students/work quietly/when/principal walk into the room

The students were working quietly when the principal walked into the room .

4 My mother/shop/when/my father phone her

My mother was shopping when my father phoned her .

8. Who said it? Match the pictures and the sentences.

1

Oh, isn't that beautiful!

b

2

Oh no, I must get away quickly!

c

3

Sh, it's laying its eggs.

d

4

I want to do that again.

a

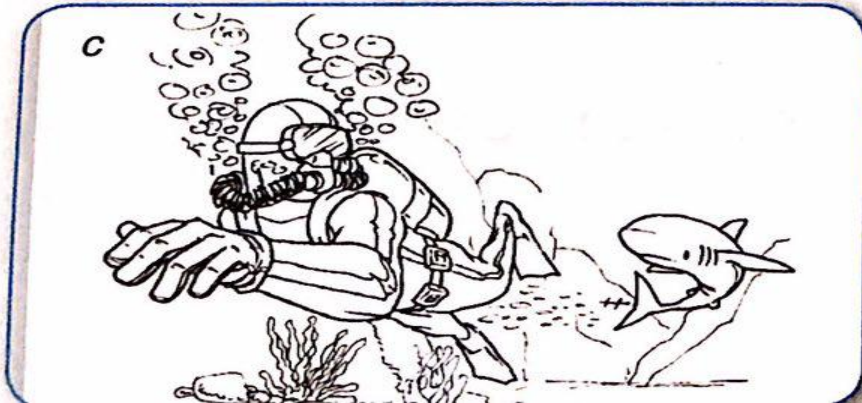
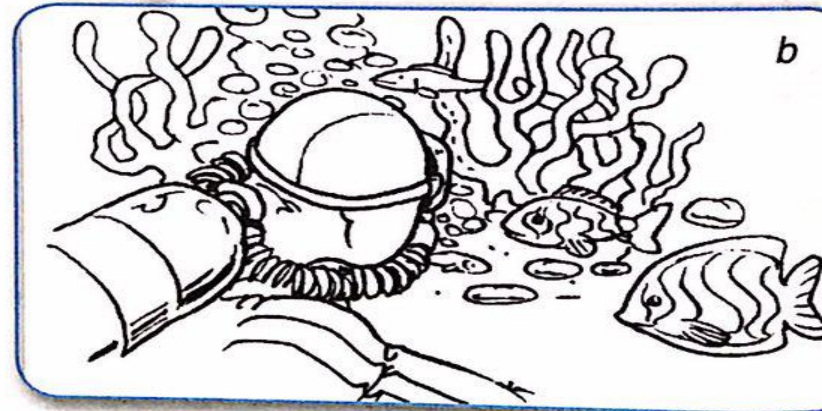
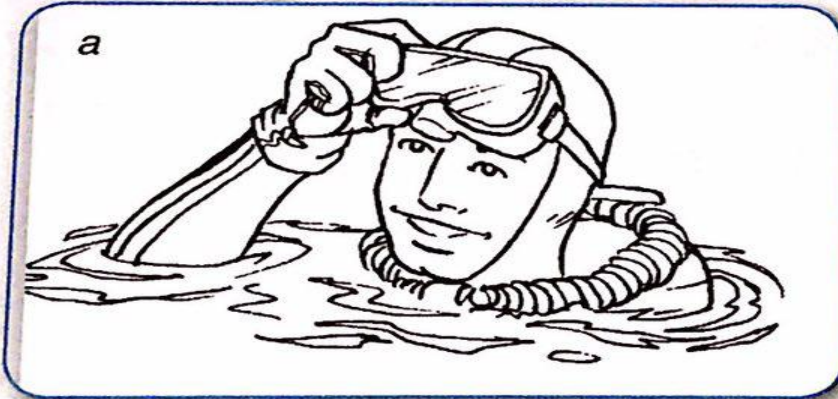

9. Choose the correct word.

1. Sharks (has/have) very sharp teeth.
2. There (is/are) shells on the beach.
3. A baby whale (need/needs) a lot of milk.
4. Some fish (look/looks) beautiful.
5. The sea (is/are) a very dangerous place.
6. Whale sharks (doesn't/don't) eat people.
7. Squid (have/has) ten legs.
8. Turtles (lay/lays) their eggs in the sand.

have

are

needs

Look

is

don't

have

lay

Writing
10. Choose and write.

<p>Choose an animal which lives in the sea. Find out about it. Write a paragraph about it. Draw a picture.</p>	<p>Tell us:</p> <ul style="list-style-type: none">- where it lives- what it looks like- if it is dangerous- how big it is- if you have seen one.- what it eats
---	--

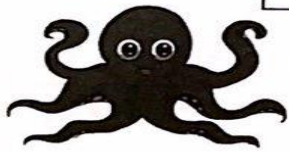

My favourite sea animal

Write it!

Draw it!

My favourite sea animal is a dolphin. I like it very much. The dolphin lives in sea water. It looks very beautiful. It isn't dangerous. It's big. It eats plants and small fish. If I see a dolphin, I will be very happy.



Writing

1. Write a plan for your story: Treasure Tree.

Setting (the place): *Where? When?*

Garden , last weekend

Characters (the people):

Who? What are they like?

My family . Father and mother

Plot (what happens) Beginning:

My family went to the garden last weekend .

Middle:

I found a treasure.

End:

My father took it to the police station and was thanked for his effort .

2. Write some words you want to use in your story.

Verbs	Nouns	Adjectives
go	treasure	honest
spend	tree	happy
play	police	nice
find	reward	fantastic

3. Use your plan to write your story.

Last weekend , I went to the park with my family .

My father brought food and drinks . I played with my sisters around a tree . The tree was very big and old .

While we were playing , I saw an old bag . It was a treasure .The bag was full of gold and diamond .

My father took the bag and went to the police station

The chief officer welcomed us and thanked us a lot .

He gave my father a reward . We felt very happy .

Module Two

Work Book

Unit Six

A BRAVE BOY

1 Read the titles of the newspaper stories. What do you think they are about?

1 **Tired driver**

2 **No bread today**

3 **Where are our phones?**

2 Now match the titles and the stories.

a **3**

Last Tuesday, four teachers lost their phones at a school in Kuwait City. The police looked round the school and asked a lot of questions but they could not find the phones. "Someone must be coming into the school, taking the phones and selling them," a policeman told me.

b **1**

Last Wednesday, a new driver was driving along the road when he fell asleep. He drove into another car. Fortunately, the drivers were not badly hurt. Both of them were taken to hospital.

c **2**

Worried people phoned firefighters when they saw smoke coming from a bakery last Thursday. The firemen arrived in ten minutes and put the fire out. The baker was not hurt. He said, "We'll make bread tomorrow but there won't be any today."

3 Answer these questions. Write a, b or c.

1. Which story happened at the weekend?

c

2. In which story did two people get hurt?

b

3. Which story is about food?

c

4. In which story did they use an ambulance?

b

5. Which stories happened at work?

a

c

6. Which story are the police still working on?

a

4 Find the past tense of these verbs in the stories.

1. lose lost

2. tell told

3. is was

4. fall fell

5. drive drove

6. see saw

7. put put

8. say said

5. Write these words with -ing in the correct column.

play have climb listen swim fall run give write win

walk + ing = walking	come + ing = coming	hop + ing = hopping
playing	having	swimming
listening	giving	winning
falling	writing	running
climbing		



Now write three more words in each column.

Remember

You can use while with past continuous.

Example:

While Ali was playing tennis, he felt down

While they were doing homework, their father came in.

6. Use the words in the box to finish the sentences.

walk watch swim listen cut

Hamad found some shells *while he was walking along the beach*

1. The lights went out **While they were watching TV.**
2. Kamel heard some beautiful music **While he was walking .**
3. Nadia and Nadra both wore goggles **While they were swimming .**
4. Basma hurt her finger **While she was cutting onion .**

7.  Tick (✓) the sentences you hear. Then say them to a friend.

1 a You run very fast.

b You ran very fast.

2 a I said, 'but'.

b I said, 'bat'.

3 a That's a big cut.

b That's a big cat.

4 a Did you say 'fun'?

b Did you say, 'fan'?

8. Read the sentences and write them in order.

- a) He saw a young boy who was drowning. **3**
- b) After this, he got an award. **6**
- c) While he was walking along the beach, he heard a scream. **2**
- d) Then he brought him safely back to the beach. **5**
- e) He quickly jumped into the sea and swam to the boy. **4**
- f) One day Waleed was at the beach with his family. **1**

1. _____

2. _____

3. _____

4. _____

5. _____

6. _____

9. Complete the sentences with words from the snake.



1 If you cannot swim, you might **drown** in the water

2 If you do something very brave, you might get an **award**..

3 The young boy was safe because Waleed **saved** him.

4 In a television **show** people might sing or talk to each other.

5 If you have a **problem** you sometimes don't know what to do.

10. Read the story about Saif and Faris. Six things are different from your Student's Book. Circle them.

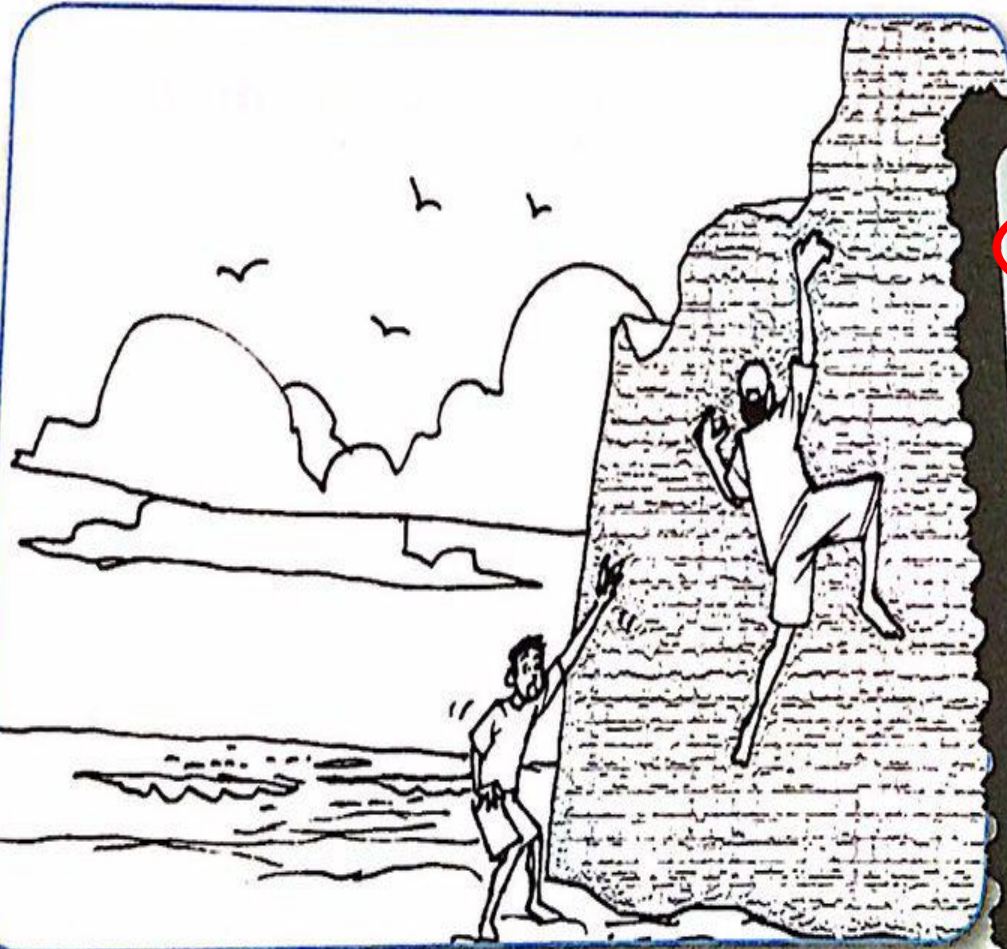

Last week Saif and Faris went to the beach. They saw a wall. Faris wanted to climb it. He fell off and broke his arm. Saif's mother phoned for an ambulance. Faris stayed in hospital for a month.

11. This story is not very interesting. Can you make it better?

Last week Saif and Faris went to the beach because _____

It was Saif's birthday .

_____ **Food and drink** _____ (Was it a holiday? Was it Saif's birthday?) They took _____.

_____ (Did they take a ball? Did they take food or a drink?)

While they were running on the beach, they saw a wall.

There was an apple tree . What was on the other side? A fruit tree? A tennis court?)

Faris wanted to climb it because _____

He wanted to eat an apple .

_____ (Did he want to jump into the water? Did he want to see something) The wall was not safe and Faris fell and broke his arm.

He screamed and didn't move .

_____ (What did he do next? Did he scream? Did he move?)

Saif's mother phoned for an ambulance and _____

Saif waited with his friend for an hour .

(How long did they wait for the ambulance?) Faris stayed in hospital for a month and _____

Faris got better . Saif visited him .

_____ (Finish the story.)

1. Read these headlines. What happened? Use your own ideas. Write sentences. Remember to answer these questions.

Who? Where? When? What happened? What happened in the end?

1 Report says children watch too much television

2 MAN GIVES MILLION AWAY

3 Diver finds huge pearl

4 Kuwait gives money to poor country

5 Police find lost child

1. A diver found a huge pearl .

2. The diver was diving in the sea .

3. He went diving last week.

4. The diver was looking for a shipwreck when he found an old box .He opened it and found a huge pearl inside .

5. He sold it and got 2 million dollars .

2. Write the full story of Fireman saves from
the Student's Book.

Remember all the information

Read the following passage then answer the question below

The great white shark is one of the most famous sharks in the world. The only shark that is larger than a great white is the whale shark. Great white sharks have been found in each of the world's oceans. Even though we can find them in waters as shallow as three feet (one meter) deep, these sharks spend most of their time in deep coastal waters.

The largest great white sharks are over six meters long. The great white sharks have huge triangle shaped teeth. The teeth of great white sharks are seven centimeters long and as they wear out, new teeth grow in to replace them.

One of the features of the great white shark is the dorsal fin. It rises out of the water when a great white swims near the surface of the ocean, The shark's tail has very strong muscles. The white shark sweeps the tail from side to side and reach speeds of upto twenty four kilometers per hour.

Scientists are unsure how long white sharks live. It is believed that their life span is almost thirty years. The great white shark is the most feared sea animal of the ocean, by both people and sea creatures.

A) Choose the correct answer from a, b, c and d:

1. The best title for the passage is...

a) The Whale Shark

b) The features of the White Shark

c) The White Shark

d) The life span of the White Shark

2. Which fact about a great white shark's size is not true?

a) White Sharks are smaller than whale sharks.

b) White sharks are not the largest sharks in the world today.

c) White sharks grow as large as whale sharks.

d) Whale sharks grow bigger than great white sharks.

3. The underlined pronoun "it" in the 3rd paragraph refers to

a) The dorsal fin

b) The water

c) The surface

d) The white shark

4. What's the opposite of the underlined word "Shallow" in the 1st paragraph?

deep

5. What's the synonym of the underlined word "wear out" in the 2nd paragraph?

Damaged

While / When

From a, b, c, and d choose the best answer:

1. While the boy his pencil broke.

- a) writing b) wrote **c) was writing** d) writes

2. The children were watching television when they asleep.

- a) falls **b) fell** c) fallen d) was falling

3. All saw his friend while he to work.

- a) walks **b) was walking** c) walking d) walked

4. I was playing tennis when I my leg.

- a) hurt** b) was hurting c) hurting d) hurts

Water Quiz True / False

A) Decide whether the following statements are True or False:

- | | T | F |
|---|-------------------------------------|-------------------------------------|
| 1. Potable water is drinkable water. | <input checked="" type="checkbox"/> | <input type="checkbox"/> |
| 2. Water exists naturally in the form of a gas, a liquid and a solid. | <input checked="" type="checkbox"/> | <input type="checkbox"/> |
| 3. Our human bodies are mostly water. | <input checked="" type="checkbox"/> | <input type="checkbox"/> |
| 4. A reservoir is a man-made lake used for water storage. | <input checked="" type="checkbox"/> | <input type="checkbox"/> |
| 5. The earth naturally recycles water faster than we can use it. | <input checked="" type="checkbox"/> | <input type="checkbox"/> |
| 6. Most plants do not die from over watering. | <input type="checkbox"/> | <input checked="" type="checkbox"/> |